



> TLAČ > KOPIR > SKENO FAX
OVAT VAT

ECOSYS M8130cidn ECOSYS M8124cidn



RÝCHLY SPRIEVODCA PRVÝMI KROKMI



pl 1LQLHMV]\SRGU'CF]QLN \$ REMDĠQLDMHG\QLHSRGVWDZRZHVSrvRE\XĪZDQLDXU]aG]HQLD
:L'CFHMLQIRUPDFMLPRĪQD)QDOHĪüZ3RGU'CF]QLNX2EVáXJL % OXEQDG\VNx3URGXFW/LEUDU\

en-BR (VWHJXLD \$ VRPHQWHH[SOLFDDVrSHUDo}HVEiVLFdVGDpITXLQD
3DUDREWHURXWUDVLQIRUPDo}HVFRQVXOWHR*XLDGH2SHUDomR % QRGLVFR3URGXFW/LEUDU\

pt-PT (VWHJXLD \$ H[SOLFDDSHQDvdVrSHUDo}HVEiVLFdVGDpITXLQD
3DUDREWHUPDLVLQIRUPDo}HVFRQVXOWHR*XLDGH2SHUDomR % QRGLVFR3URGXFW/LEUDU\

ro \$FHVWJKLG \$ H[SOLFãGRDURSHUDĠLXQLOHGHEd)ãDOHDSUDWXOXL
3HQWUXDOWHLQIRUPDĠLLFRQVXOWDĠL*KLGXOGH2SHUDUH % GHSHGLVFXO3URGXFW/LEUDU\

RU Cœ-fjñifñi|vzizelñj á iicœ-fjœliqævñifñijœjyie-ycœd|ñiivñifñiñ fñ|ñiivñifñiñ fñ|ñiivñifñiñ ♦zifñ fññ
üqñc|yqæñjœjñjœjñfññzñiññiññfññzñiññvññq|œ-fjœ-ycœ ç fjœœœñj3URGXFW/LEUDU\

sv ,GHQKIUXLGHQ \$ IJUNODUDVHQGDVVPDNLQHqVJUXQQNwLRQHU
)|UDQQDQLQIRUPDwLRQKIQYLVdVWLOOEUXNVdQYLVQLQJHQ % SnVNLYDQ3URGXFW/LEUDU\

TR %XNÖODYX] \$ VDGHFHPDNLQHQLQWHPHOLüOHPOHULQLDöNODU
'L÷HUELOJLOHULöLQ3URGXFW/LEUDU\GLVNLQGHNLDöDÖüWÖUPD. ÖODYX]XQD % EDNÖQÖ]

ar

هذا الدليل (A) يشرح فقط عمليات تشغيل الجهاز الأساسية.
لمزيد من المعلومات، راجع دليل التشغيل (B) الموجود على قرص Product Library.

on

C Odblokovat' zámok skeneru (iba ECOSYS M8130cidn)

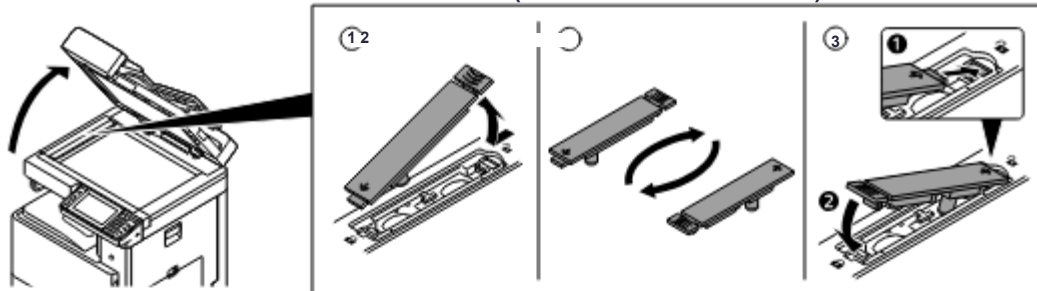

D Nainštalujte zásobník na oddelenie úloh a nádobu s tonerom

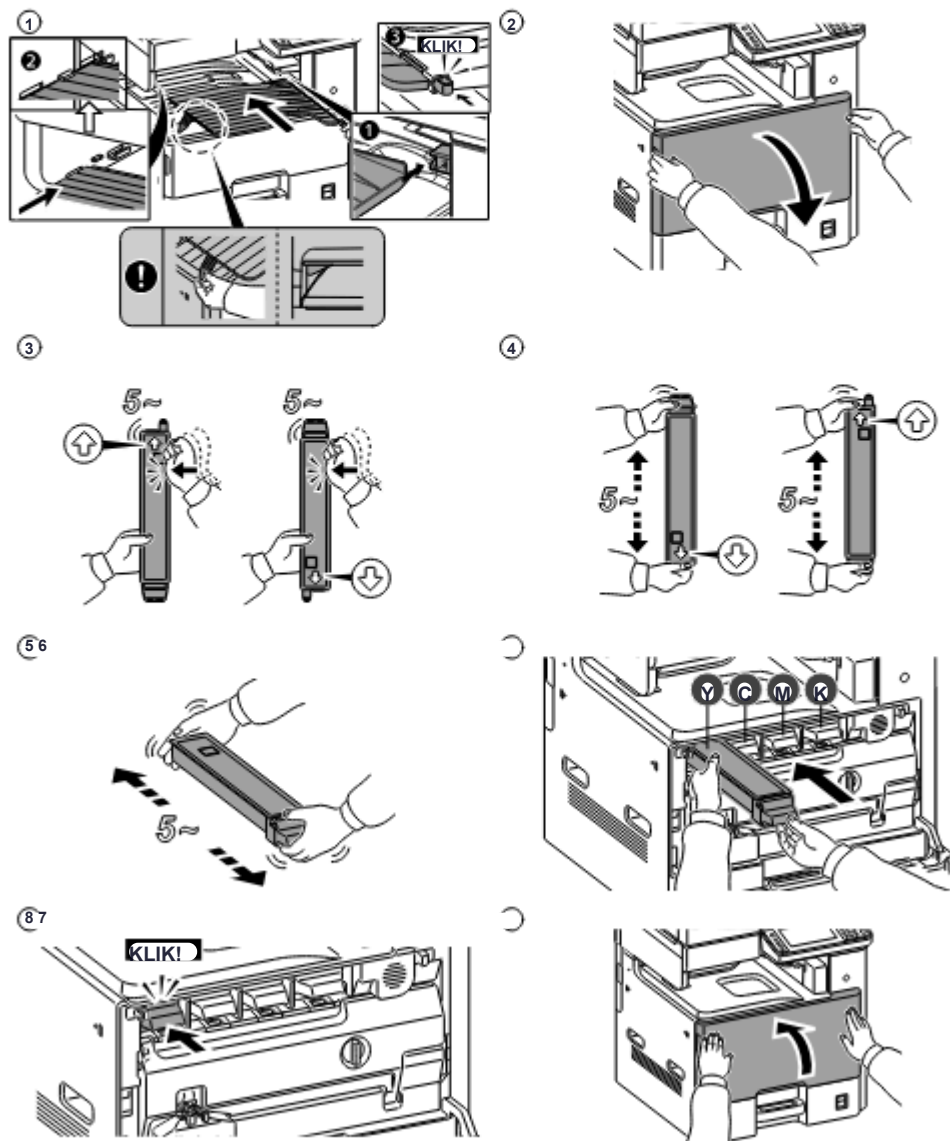

E Načítajte papier

12

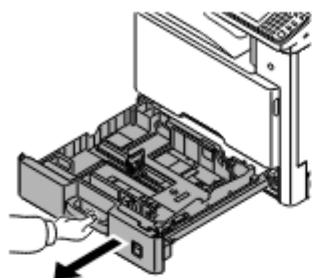

13

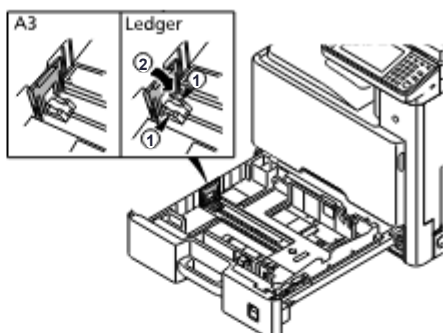

34

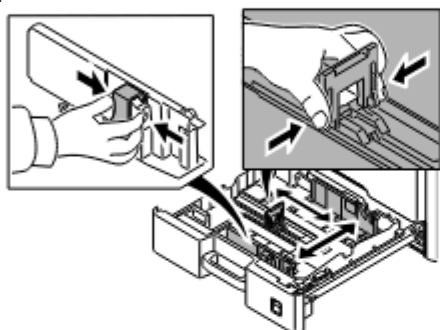

14

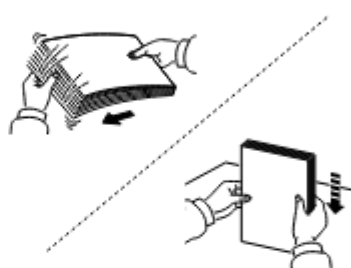

5

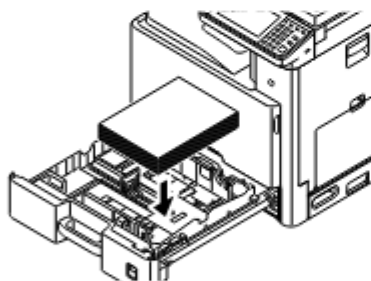

6

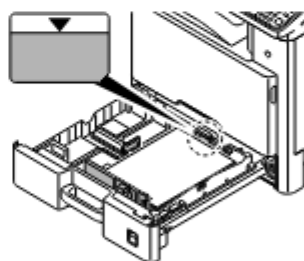

78

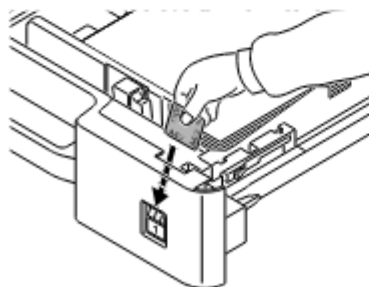

15

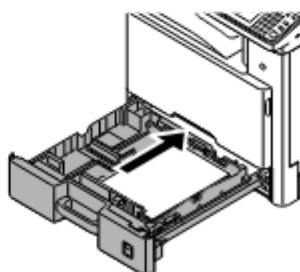

F Pripojte káble

LAN

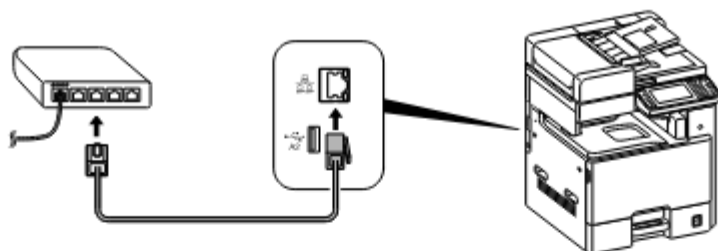

USB

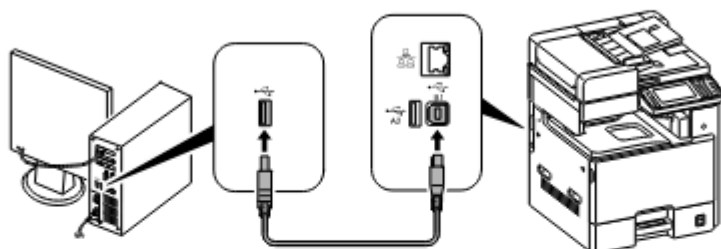

G Vymeniť panel ovládania

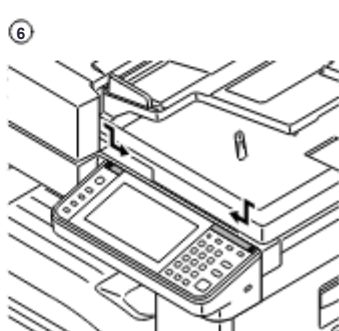
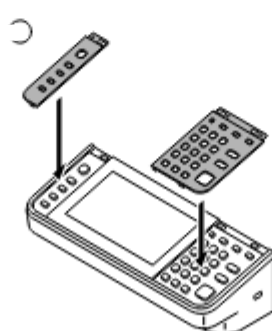
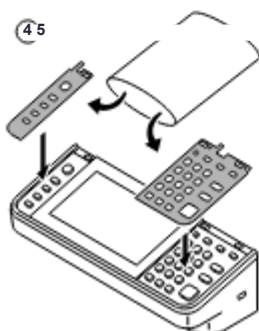
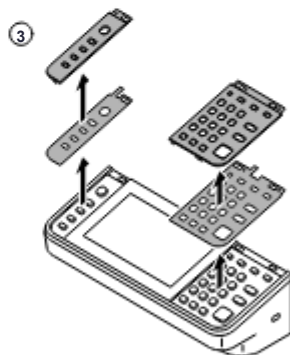
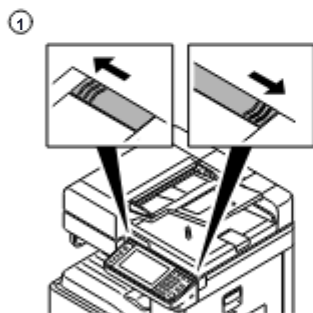

H Pripojte napájací kábel

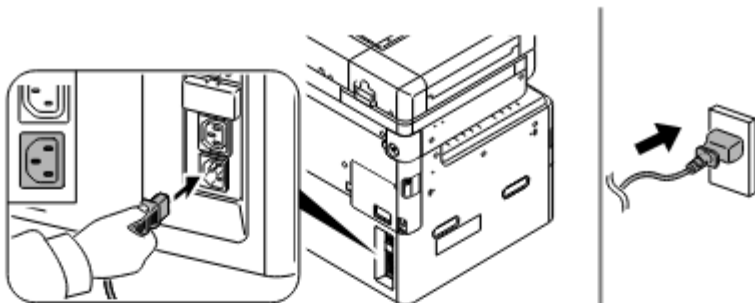

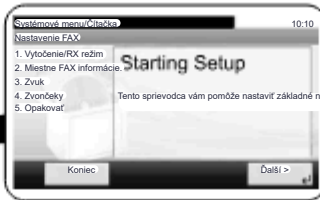
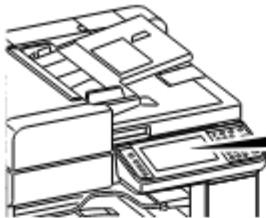

v Stroj poskytuje Quick Setup Wizard v systéme Menu na nastavenie nasledovného podľa potreby:

1. Nastavenie FAX
2. Nastavenie šetriace energiu
3. Nastavenie siete Postupujte podľa pokynov na ovládacom paneli.

en DPiTXLQDGLVSRQHGHXQ\$VLVWHWHGHGFRQILJXUDFL3Q
JiSLGDHQHO0HQ-6LVVHPDXTXHSUPLWFRQILJXUDUOR
nasleduje podľa potreby:

1. Nastavenia faxu
2. Nastavenia úspory energie
3. Konfigurácia siete Postupujte podľa pokynov v ovládacom paneli.

CA Vaše zariadenie obsahuje Sprievodcu rýchlym nastavením v systémovej menu na konfiguráciu nasledujúcich možností podľa potreby:

1. Konfigurácia FAX
2. Nastavenia úspory energie
3. Nastavenie siete Postupujte podľa pokynov v operačnom paneli.

by RQHHLQPXNDQDWRLLPLWHWDDQMUMHVWHQPIYDOLNRVVVD
RKMDWXXSLNDVHVXVRKMHOPDVHXUDDYLDHQDVHVXNVHHQ
Ak je to potrebné:

1. Inštalácia faxu
2. Inštalácia úspor energie
3. Sieťové nastavenie

IRXGDWDNI\WW\SDQHHLQQRKMLHWD

CS 9V\VWpPRYpODEtGFHJDGtJHQtMHNGLVSRJLFL
SUHYRGFHu\FKQePODVWDYHQpSRPRFtNWHUpK
R PHaHWHQitVOHGXMtItQDVWDYDLWGOHSRWGHE\

Například.
1DVWDYHQtVSRGLpHHQHJULH
1DVWDYHQtVtWČ
3RVXWSXMMWHSRGOHSRN\QhQDSURYR\QitPSDQHOX

To Stroj poskytuje v systémovej menu Sprievodcu rýchlym nastavením na konfiguráciu nasledujúcich, ak je to potrebné:

1. Nastavenie faxu
2. Konfigurácia šetrenia energie
3. Nastavenie siete Postupujte podľa pokynov na ovládacom paneli.

da Stroj ponúka rýchly nastavovací návod v systémovej menu na nastavenie podľa potreby:

1. Nastavenie faxu
2. Nastavenie režimu úspory energie
3. Nastavenie siete

)iJDQYLVQLQJHUQHSnEHWMHQLQJVSdqHOHW

hu \$NpV\OpN5HOGVjHUPHOMpEHQWDoiOKDWy
*RUVEHiOOtWiVYDUijVOyVHjtWVpYHODJ
DOiEELDN iOOtWKDWyNEH

);EHiOOtWiV
(QHULDWDNDUpNRVViJEHiOOtWiVD
+iOyJDWEHiOOtWiVD
,YHVVDHNHjHOESXOWRQPHJMHOHQEXWdVtWiVRNDW

z Zariadenie má v systémovej menu

6FKQHOHLQVWHOOXQJ\$SVLVVWHQWHQXPEHL%HGDUi
:

1. Nastavenie faxu
2. Nastavenie úspory energie
3. Nastavenie siete

)RjHQ6LHGHSQ\$ZHLVXQJHQDXIGHP%GHLHQIHOG

To Stroj ponúka Quick Setup Wizard v systémovej menu na konfiguráciu nasledujúcich položiek:

1. Nastavenie FAX
2. Nastavenie režimu úspory energie.
3. Nastavenie siete Postupujte podľa pokynov na ovládacom paneli.

The NL m-cz b d e v . t e z i t e u t e r e c i . a r z i a o
a l s e u i a z o q u i j a u h i u o i p k s l i j o u t i u z
q s 3 t i s u a h a i i q i i r u j a e l a b i a i t i j i j i t
E o s 3 t i s i n e
e o s 3 t i s a i t i j i j a q u i b . e h i t i j i e s 3 s i s b
e h r d u i s j b
e s 3 r i i s s t b a t i j i o n 8 i i j 3 n 8 s r i u t t 8 n i s u r i b a n 8 i j i j p
f s u i h u i t i j u r h a f i i j z i t i t i j i j a q u i b

Zariadenie má v systémovej menu Sprievodcu zrýchleným nastavením na nastavenie nasledujúceho:

1. Nastavenie FAX
2. Riešenie úspory energie
3. Konfigurácia siete Postupujte podľa pokynov na ovládacom paneli.

1



2

en

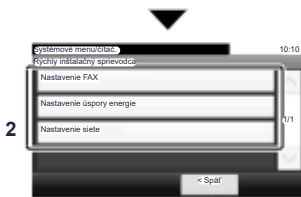
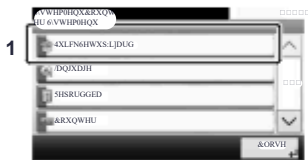

ca

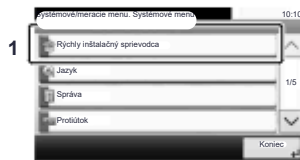

cs

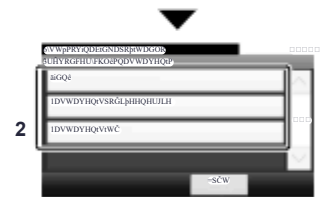

da de



el

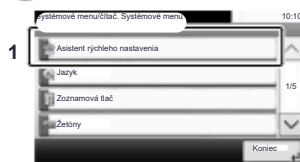

el

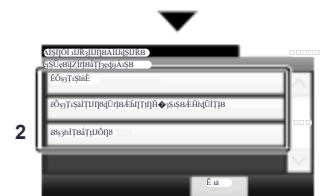

es

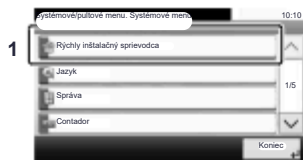

fi

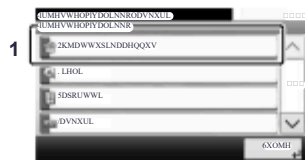

fr

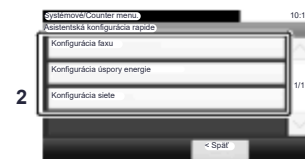
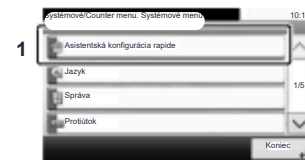

hu

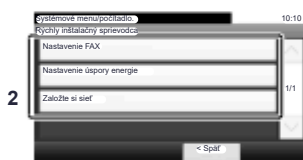

it

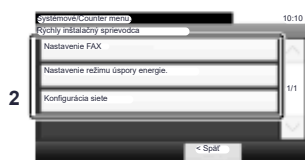

nl

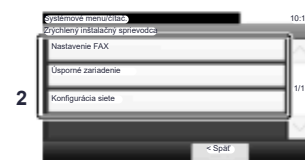

no

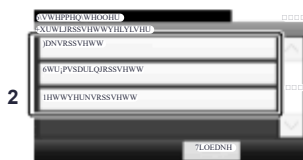

pl

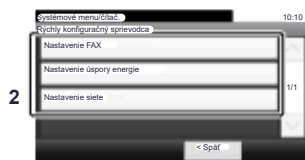

pt-BR

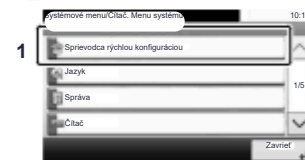

hu

1 -HOHQWpV

2 Vytlačte správu >

3 EOODSRVROGDO



it

1 :SDSRUWR

2 Tlačová správa >

3 :DILQDV'DWR

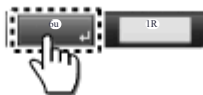

nl

1 :SDSRUW

2 :SDSRUWDIGUXNNHQ >

3 :6WDWXVSDILQD

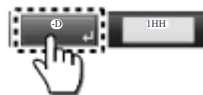

nie

1 :SDSRUW

2 :SDSRUWXWVVNULIW >

3 :6WDWXV



pl

1 :SDSRUW

2 :SDSRUWXMGUXNRZQLH >

3 :6WURQDVWDQX



pt-BR

1 :Správa

2 :PSUHVVmrGHUHODWyULR >

3 :3ULQDGHVWDWXV

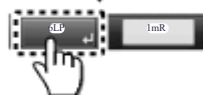

pt-PT

1 :Správa

2 Tlačová správa >

3 :3ULQD'VWDGR

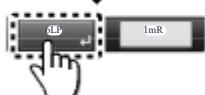

ro

1 :SDSRUW

2 Tlačová správa >

3 :3DILQ66WDUH



ru

1 :Илгя

2 :Илгя-Илгя >

3 :Илгя Илгя

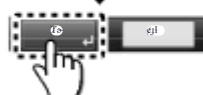

sv

1 :SDSRUW

2 Tlačová správa >

3 :6WDWXVVLGD

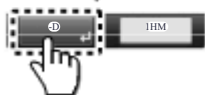

tr

1 :Správa

2 Rapor Yazdırma >

3 Stránka so stavom

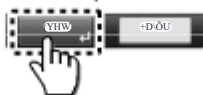

ar

1 :ZDRAVOTNICTVO

2 :C C C C >

3 THE TEXT

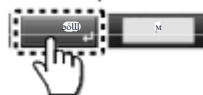



إذا ظهرت نافذة تم العثور على جهاز جديد ، انقر على إلغاء.

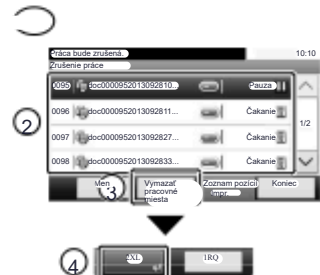
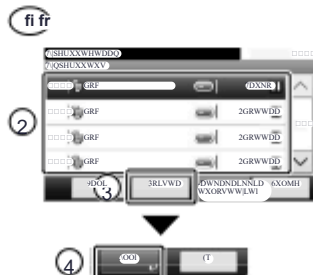
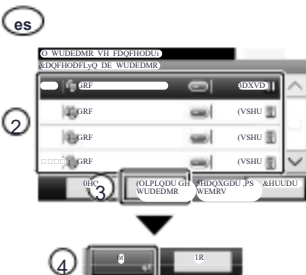
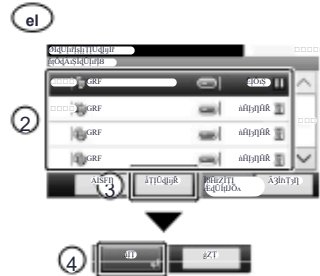
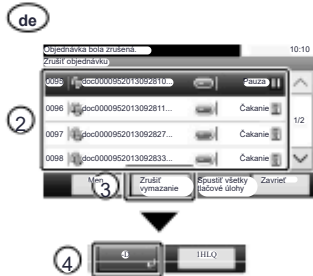
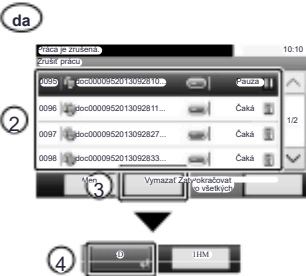
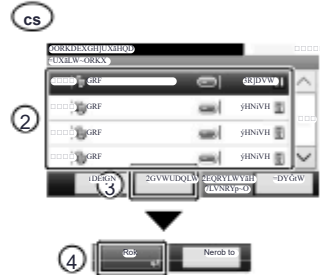
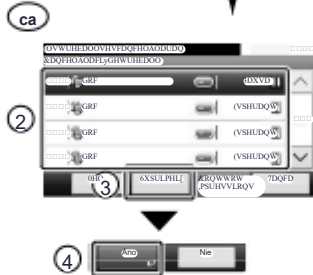
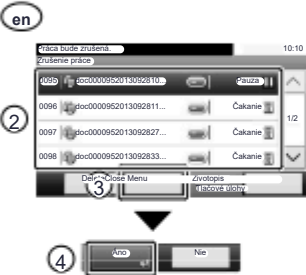
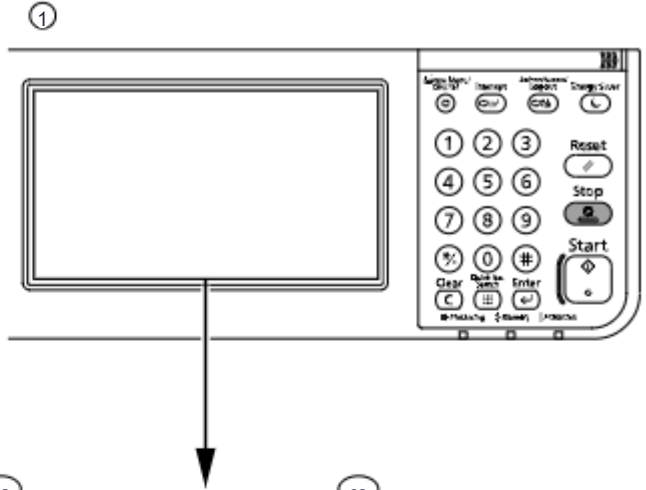
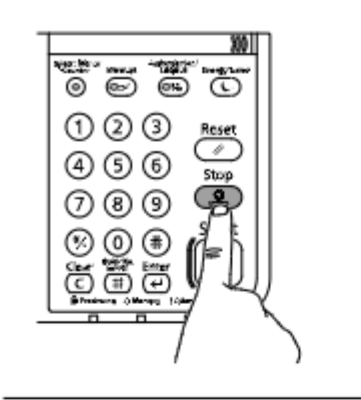

1

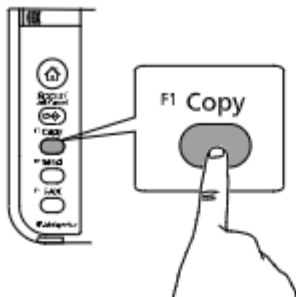

2

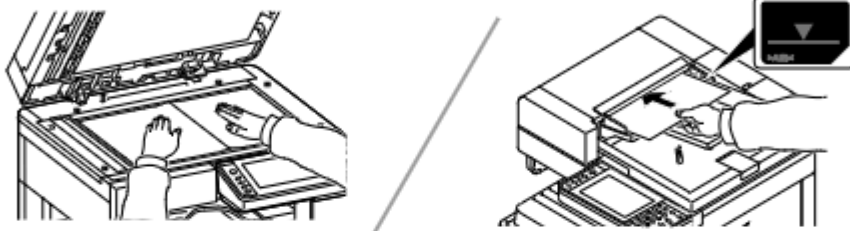

3

V

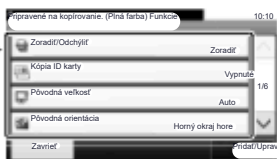
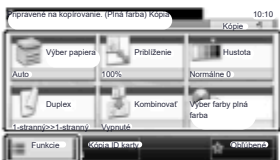

CA

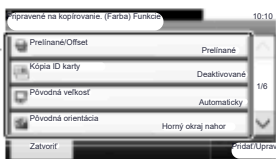

CS

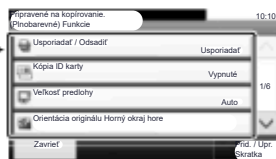

Z

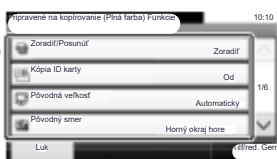

Č

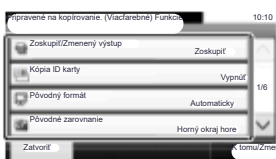
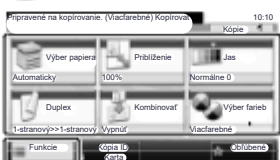

The



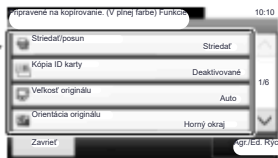
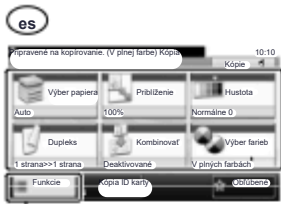

Príklad: Rýchle prístup.

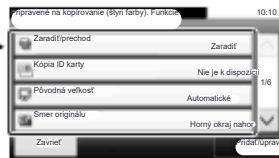

Príklad: Upravívač skratky.

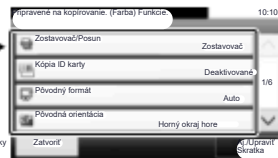
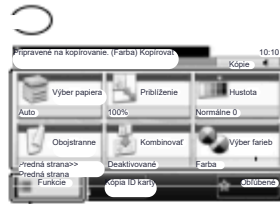

Príklad: Upravívač skratky.

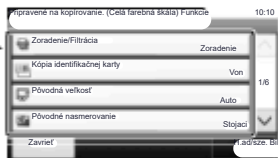

Príklad: 60 par.

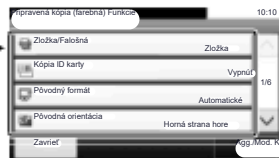
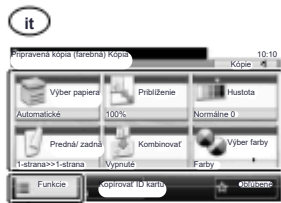

Príklad: Kľúčová skratka

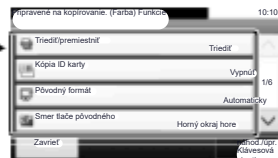
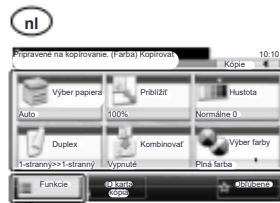

Príklad: Upravívač skratky

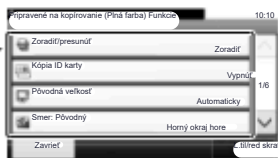

Príklad: Blied skratka

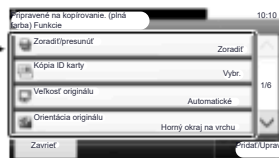

Príklad: Upravívač skratky

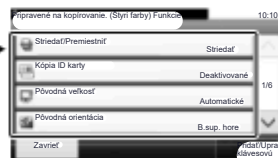

Príklad: Upravívač skratky

Nastavenie

en

- 1 Spustite svoj webový prehliadač. Do
- 2 adresného alebo lokalizačného riadku zadajte IP adresu zariadenia alebo názov hostiteľa tlačiarne.



Stránka stavu

Sieť TCP/IP

Názov hostiteľa tlačiarne: KMA2FA6A
IPv4
IP adresa: 192.168.48.21

- 3 Zadajte nasledujúce a prihláste sa do Command Center RX s administrátorskými oprávneniami.

Administratívne

Používateľské meno Heslo Admin

- 4 V menu [Nastavenia funkcií] kliknite na [E-mail]. Nastavte SMTP protokol
- 5 [Zapnúť] a potom zadajte nasledujúce položky.

- Názov SMTP servera
- Maximálna veľkosť e-mailu
- Adresa odosielateľa

ca cs

- 1 Spustite webový prehliadač. Do adresného alebo lokalizačného riadku zadajte IP adresu zariadenia alebo názov hostiteľa tlačiarne.



Stránka so stavom

Sietový TCP/IP

Názov hostiteľa tlačiarne: KMA2FA6A
IPv4
IP adresa: 192.168.48.21

- 3 Zadajte nasledujúce údaje a prihláste sa do Command Center RX s administrátorskými oprávneniami.

Administratívne

Používateľské meno Heslo Administratíva Administratíva

- 4 V menu [Nastavenia funkcií] kliknite na [E-mail].

- 5 Nastavte protokol SMTP na [Zapnúť] a zadajte nasledujúce údaje.
- Názov servera SMTP
 - Limit veľkosti e-mailu
 - Adresa odosielateľa

es

- 1 6SXVGVWHYiaZHERRYsURK0tãHþ
- 2 9j)ORãFHSGUHVDDQHER8PVGHQjJDGHMWH ,3DGLUHVXJdGtJHQiQHERMPpQRKRVLWLV OVnp WLvNiUQ\



Stránka so stavom

Sietový TCP/IP

Názov hostiteľa tlačiarne: KMA2FA6A
IPv4
IP adresa: 192.168.48.21

- 3 =DGHMWHQãHXHYGHQjLQIRUPDFHDS GLKODVWH se do Command Center RX s DGPLQLVWUjWRUVNëPRSUjYQCQP

Administratívne

8ãLYDWHO Vnp MPpQR Administratíva
Heslo Administratíva

- 4 9QDEiGFH>1DVWDYHQiXQNFt@NOL NQÇWHQD [E-mail]. Nastavte protokol

- 5 SMTP na [Zapnúť], a SRWpJDGHMWHQjVOHGXMfTSRORãN \iijHYVHUyHUX6073
- Limit veľkosti e-mailu
 - Adresa odosielateľa

da

- 1 Spustite svoj webový prehliadač.
- 2 Zadajte IP adresu stroja alebo názov hostiteľa tlačiarne do adresy alebo adresy SODFHULQJVOLQMHQ



Stránka stavu

Sieť TCP/IP

Názov hostiteľa tlačiarne: KMA2FA6A
IPv4
IP adresa: 192.168.48.21

- 3 Zadajte nasledujúce a prihláste sa do Command Center RX s administrátorskými oprávneniami.

Administratívne

Používateľské meno Heslo Administratíva Administratíva

- 4 V ponuke [Nastavenia funkcií] kliknite na [E-mail]. Nastavte protokol SMTP na
- 5 [Zapnúť] a zadajte nasledujúce údaje.

- Názov SMTP servera
- Obmedzenie veľkosti e-mailov
- Adresa odosielateľa

de

- 1 Spustite svoj webový prehliadač. Do adresného riadku zadajte IP adresu zariadenia alebo názov hostiteľa ako internetovú adresu (URL).

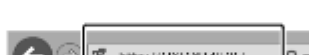

Stránka stavu

Sieť TCP/IP

Názov hostiteľa tlačiarne: KMA2FA6A
IPv4
IP adresa: 192.168.48.21

- 3 Zadajte nasledujúce a prihláste sa do Command Center RX s oprávneniami administrátora.

Administratívne

Používateľské meno Heslo Administratíva Administratíva

- 4 V ponuke [Nastavenia funkcií] kliknite na [E-mail]. Nastavte protokol SMTP na
- 5 [Zapnúť] a zadajte nasledujúce položky.

- Názov SMTP servera
- Limit veľkosti e-mailov
- Adresa odosielateľa

el

- 1 Začinite svoj webový prehliadač. Do adresného riadku zadajte IP adresu zariadenia alebo názov
- 2 hostiteľa ako internetovú adresu (URL).

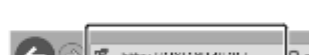

Stránka so stavom

Sietový TCP/IP

Názov hostiteľa tlačiarne: KMA2FA6A
IPv4
IP adresa: 192.168.48.21

- 3 Zadajte nasledujúce a prihláste sa do Command Center RX s oprávneniami administrátora.

Administratívne

gHñjI ZqRiIjS Administratíva
ÄÄjTte8 Administratíva
ãçñiIjS8

- 4 Nastavte SMTP protokol na [Zapnúť] a zadajte nasledujúce položky.
- 5

- Názov SMTP servera
- Limit veľkosti e-mailov
- äTjOš8HjSjIjIjIj3ñI

es

- 1 Spustite webový prehliadač. Do adresného riadku alebo riadku umiestnenia zadajte IP adresu počítača alebo názov hostiteľa tlačiarne.

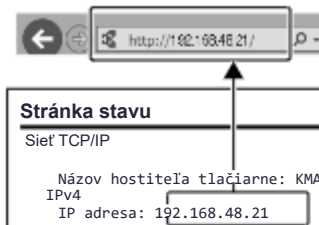

fi

- 1 Spustite svoj internetový prehliadač.
- 2 Zadajte IP adresu do adresného riadku alebo riadku umiestnenia názvu hostiteľa počítača alebo servera tlačiarne.

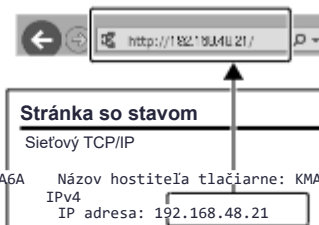

fr

- 1 Spustite internetový prehliadač. Do riadku adresy alebo polohy zadajte IP adresu zariadenia alebo názov hostiteľa tlačiarne.

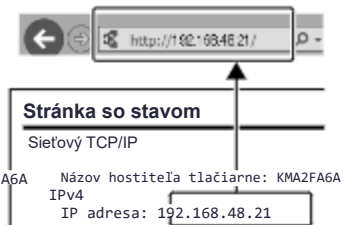

- 3 Zadajte nasledujúce a prihláste sa do Command Center RX s administrátorskými právami.



- 4 V menu [Nastavenie funkcie] kliknite na [E-mail]. Nastavte protokol SMTP na [Aktívované] a potom zadajte hodnoty nasledujúcich položiek.

- Názov SMTP servera
- Veľkosť obmedzenia e-mailu
- Adresa odosielateľa

- 3 Zadajte nasledujúce a prihláste sa do Command Center RX s administrátorskými povereniami.



- 4 Kliknite na [E-mail] v menu [Nastavenie funkcie]. Nastavte protokol SMTP na [Povolené]

- 5 a zadajte nasledujúce údaje.
 - Názov SMTP servera
 - Obmedzenie veľkosti e-mailu
 - Adresa odosielateľa

- 3 Zadajte nasledujúce informácie a prihláste sa do Command Center RX s administrátorskými právami.

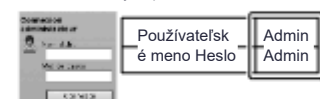

- 4 V menu [Nastavenia funkcií] kliknite na [Email]. Nastavte protokol SMTP na [Zapnuté] a potom zadajte nasledujúce informácie.

- Názov SMTP servera
- Lim. Veľkosť e-mailu
- Adresa odosielateľa

hu

- 1 >OGVVDHODZHEE|Q|pVjEMpW
- 2 Do adresného alebo lokalizačného riadku zadajte IP adresu zariadenia alebo názov hostiteľa tlačiarne.

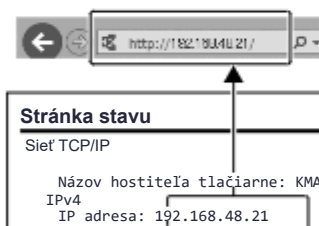

- 3 Zadajte nasledujúce a prihláste sa do Command Center RX s administrátorskými oprávneniami.



- 4 V menu [Nastavenia funkcií] choďte na NDWWWLQWVRQD]>(PDLO@OHKHWEVpJUH
- 5 Prepnite možnosť protokolu SMTP na [Zapnuté] a zadajte nasledujúce položky.

- Názov SMTP servera
- Limit veľkosti e-mailu
- Adresa odosielateľa

it

- 1 Spustite webový prehliadač. Do adresného riadku zadajte IP adresu zariadenia alebo názov hostiteľa tlačiarne.

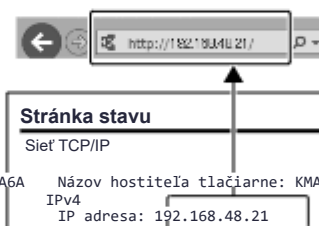

- 3 Zadajte nasledujúce položky a prihláste sa do Command Center RX s administrátorskými právami.



- 4 V ponuke [Nastavenia funkcie] kliknite na [E-mail]. Nastavte protokol SMTP na [Zapnuté], potom zadajte nasledujúce položky.

- Názov SMTP servera
- Obmedzenie veľkosti e-mailu
- Adresa odosielateľa

nl

- 1 Spustite svoj webový prehliadač. Do adresného alebo umiestňovacieho riadku zadajte IP adresu zariadenia alebo názov hostiteľa tlačiarne.

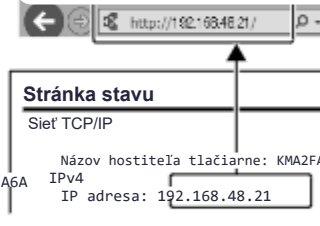

- 3 Zadajte nasledujúce a prihláste sa do Command Center RX s administrátorskými právami.

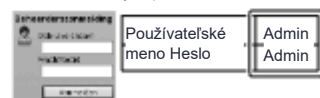

- 4 V ponuke [Nastavenia funkcie] kliknite na [E-mail]. Nastavte protokol SMTP na [Zapnuté] a potom zadajte nasledujúce položky.

- Názov SMTP servera
- Obmedzenie veľkosti e-mailu
- Adresa odosielateľa

sv

- Spustite svoj prehliadač. Zadajte IP
- adresu zariadenia alebo názov hostiteľa tlačiarne do adresného riadku.

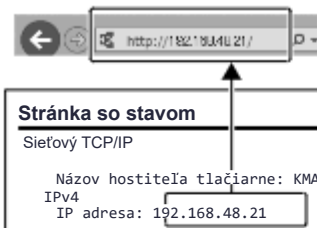

- Zadajte nasledujúce a prihláste sa do Command Center RX ako administrátor.



- V menu [Nastavenia funkcií] kliknite na [Email]. Povolte SMTP protokol
- [Zapnuté] a potom zadajte nasledujúce informácie.
 - Názov servera SMTP
 - Limit veľkosti e-mailu
 - Adresa odosielaťa

TR

- HEWDUDÖFÖQÖJÖDöÖQ
- SGUHVYHD<HUöXEX=XQDPDNLQ
HQLQ,3 DGUHVVLQDJÖQ

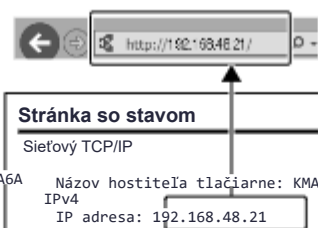

- SüD=ÖGDNLÖHULLULQYH\QHWLFL\HWNLV
LÖH &RPPDQG&HQWHU5; GHRWXUPDöÖQ



- >RQNVL\RQ\$DUODUÖ@PHQVQGHQ >
(SRVWD@]JHULQHWÖNODÖQ
- 607%SURWRNRÖD\DUÖQÖ>\$ö ÖN@NRQXPXQD
JHWLULQYHVVRQDDöD=ÖGDNL]-HÖHULD]ÖQ
- 60736XQXFSSGÖ
- (SRVWD%RXWX6ÖQÖUÖ
- Adresa odosielaťa

ar

- اطبع مستعرض الإنترنت الخاص بالآلة
في نموذج المربع أو عنوان أمتل عنوان IP الخاص بالمبيوتر
أو اسم مدينت الطباعة.

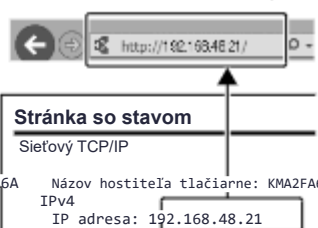

- أدخل ما يلي وسجل للدخول في Command Center RX
بامتيازات المدير المسؤول.



- من القائمة [إعدادات الوظائف] انقر فوق [البريد الإلكتروني]
- أضبط بروتوكول SMTP على وضع [متشغيل]. ثم املأ
الخصائص التالية.
 - اسم خادم SMTP
 - محدد حجم البريد الإلكتروني
 - عنوان المرسل

Odoslat'

①

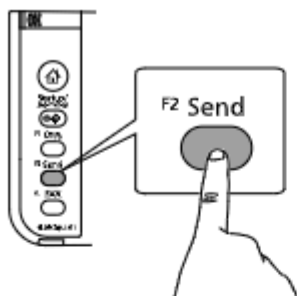

②

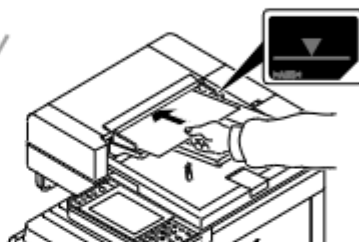

③

1



2

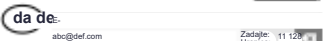
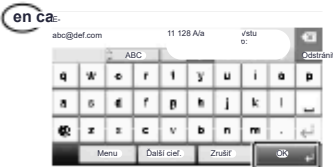

4

1

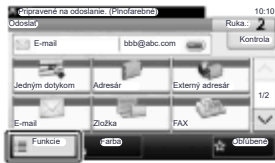

2 en ca

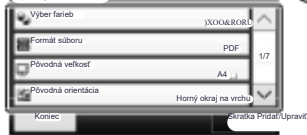

da



de

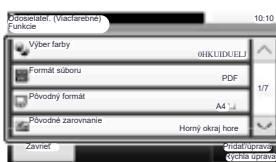

el



es

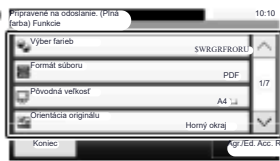

fi

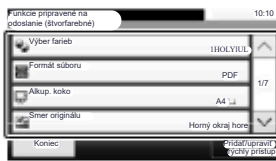

fr

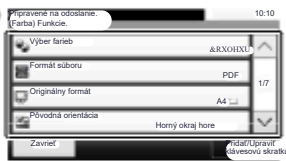

hu

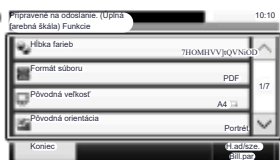

it



nl

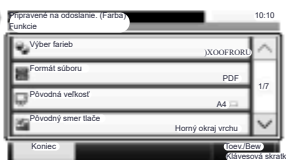

no

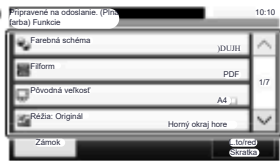

pl

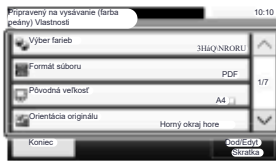

pt-Br

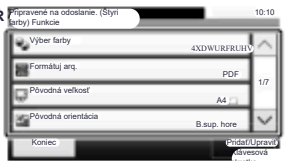

pt-PT



ro ru



ru

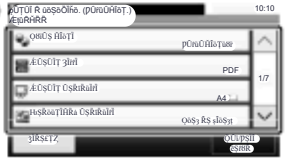

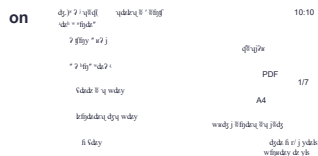
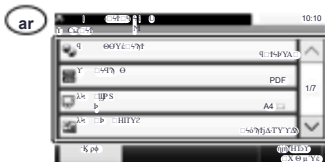
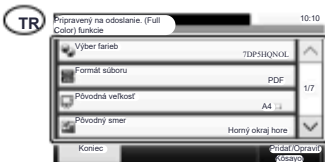
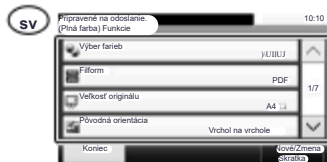

5

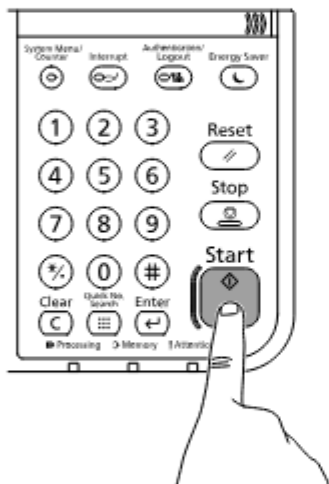

4

1



2

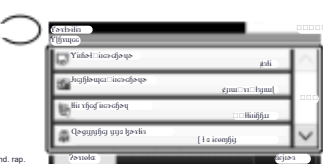
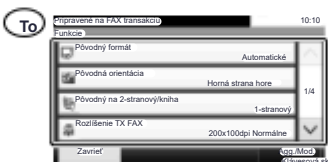
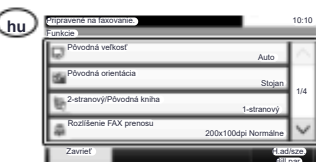
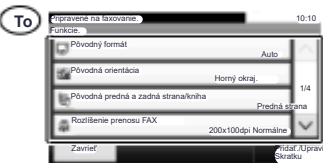
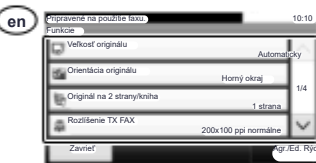
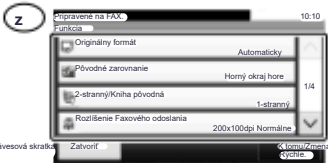
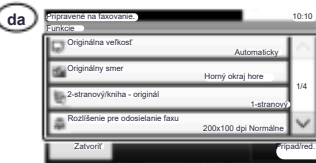
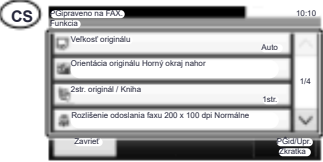

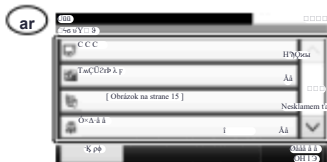
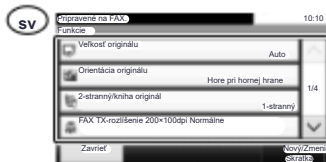

on **Príprava poslať FAX** 10:10

Príprava

Velkosť originálu Automaticky

Orientácia originálu Horný okraj hore 1/4

2-stranný/Kniha originál 1-stranný

Rozlíšenie FAX TX + 200×100dpi Normal

Zavrieť **Poslať/Opravu**

5

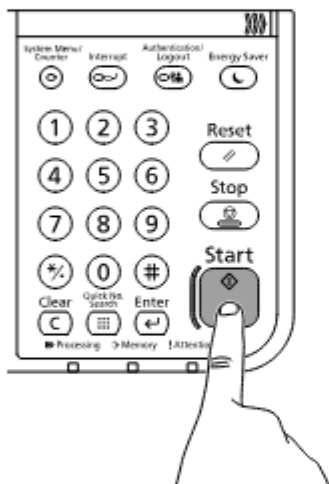



لتسهيل الطباعة الشخصية من جهاز الكمبيوتر، عين العنصرين رقم 1 و2 في الصفحة.

Z operačného panelu

①

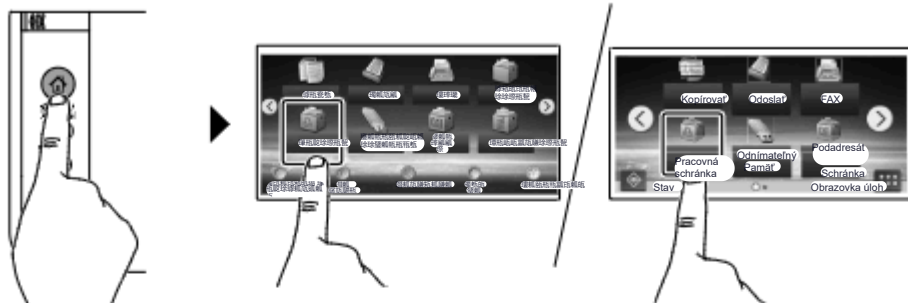

②

en



ca



cs



da





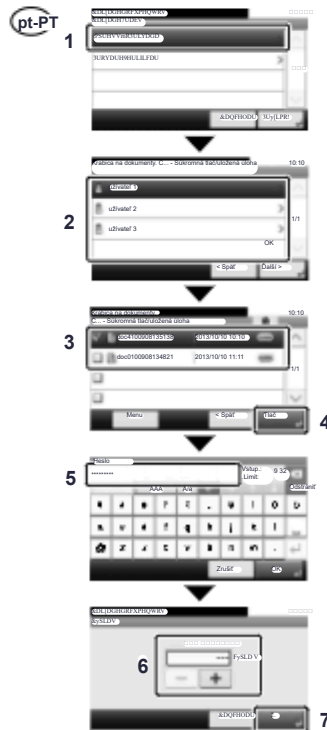
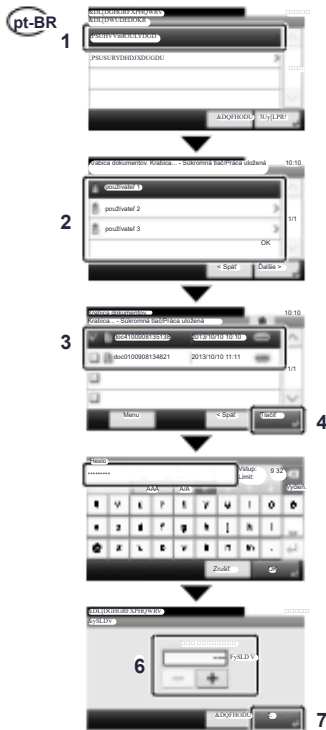
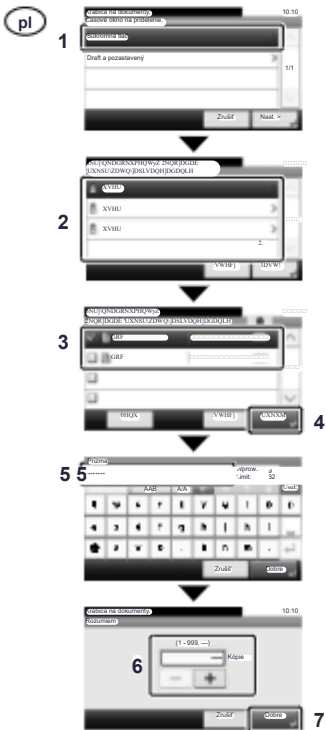
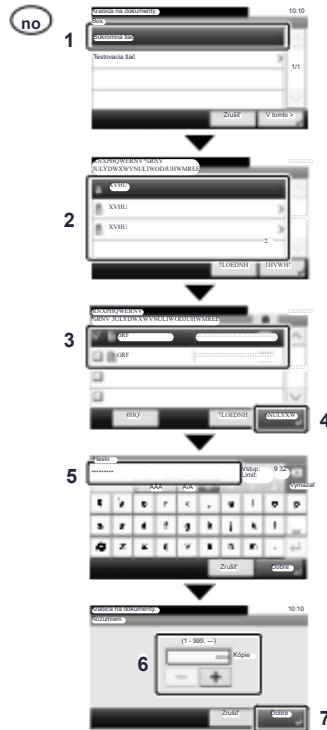
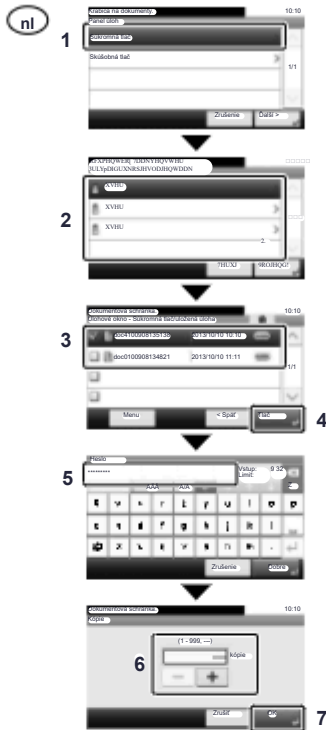
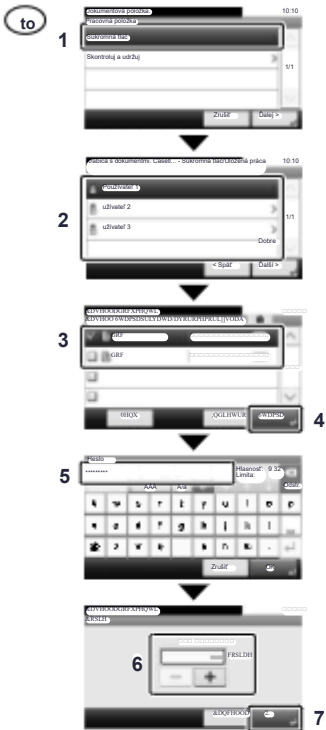

ro ru

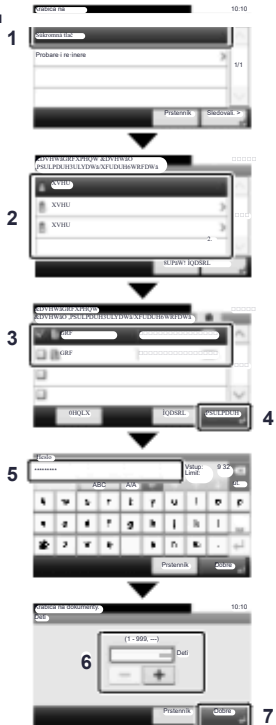

ar

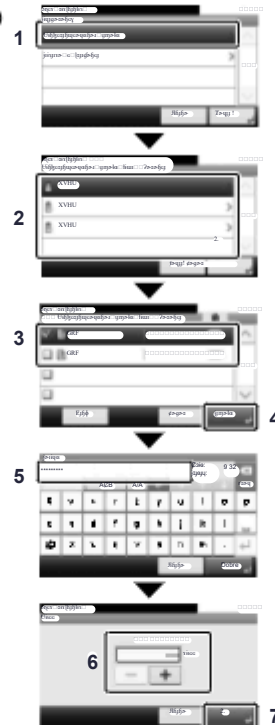

sv

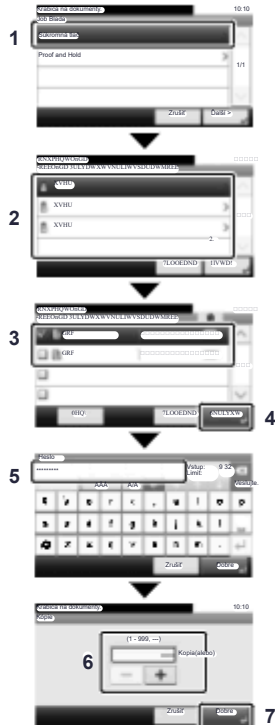

tr

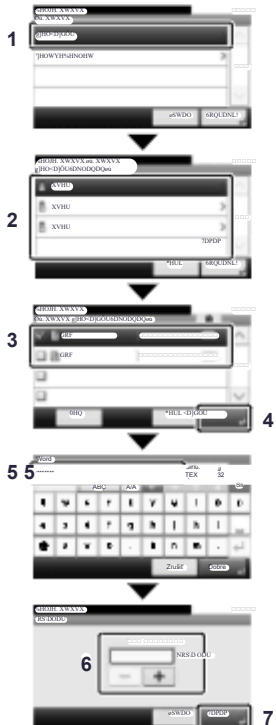

he

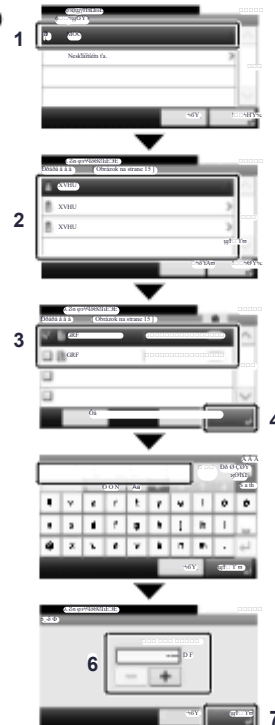



في حالة حدوث خطأ في الجهاز، تظهر رسالة الخطأ على الشاشة وكذلك بوضوح مؤشر Attention على لوحة التشغيل أو بومبس. راجع دليل التشغيل للتخلص من الخطأ للحصول على تفاصيل، راجع دليل التشغيل على قرص Product Library



في حالة انتشار الورق، اتبع التوجيهات الموجودة على لوحة التشغيل لإخراج الورق المحشور.

**QUALITY
CERTIFICATE**

Thermiflex is the leader
of quality printers and
fax copiers.



2017.7
302P35601001



302-3560 031

